

PropNET Module

Propeller Platform Connections

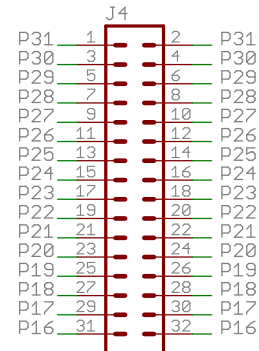

1-Wire Connections

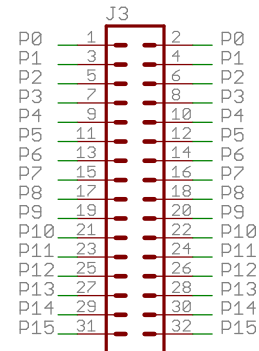
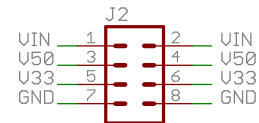
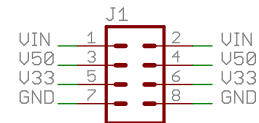
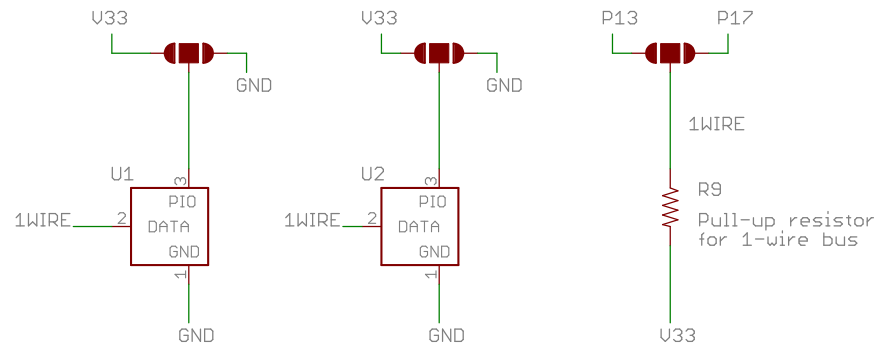

WIZ812MJ Connections

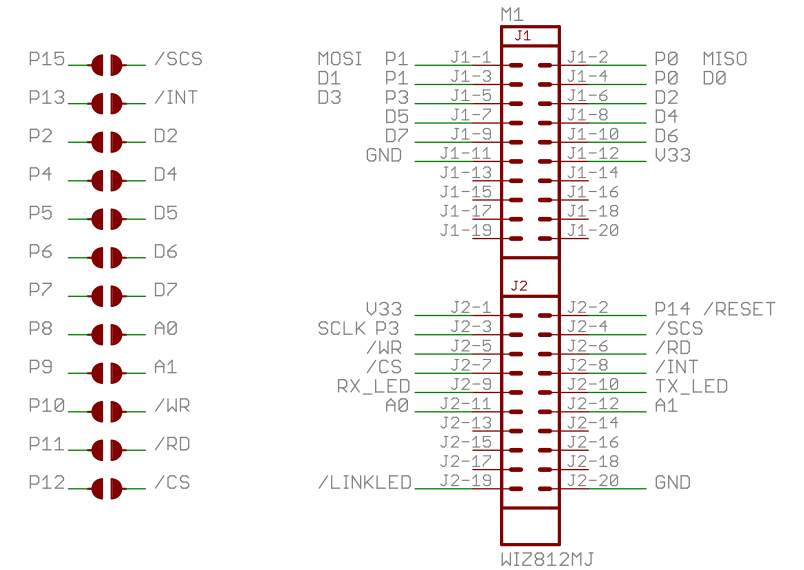

User Interface and MoBo connector

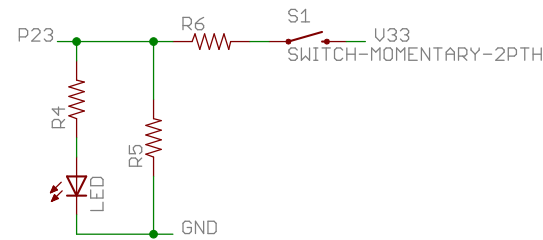

RTC Clock and power

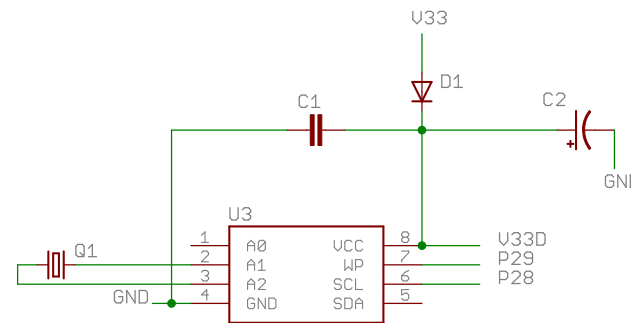

Note, the IC signal lines doesn't match RTC pinout

uSD Card Adapter

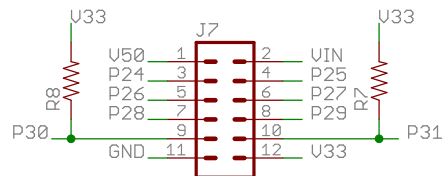
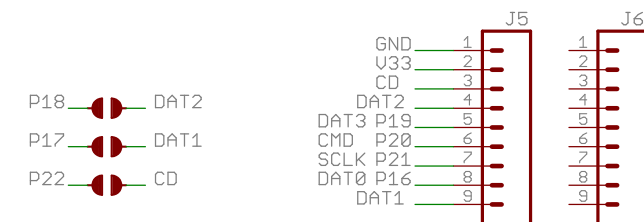

Purveyor of Prototyping Goods www.brillidea.com	PropNET Module	
	Rev:0 Jan 30, 2010	
	Sheet: 1/1	